

Powered by



MU 1000S ▶ 2V 1000Ah

MU1000S is a long service life battery up to 20 years expected life under normal float charge. As with all CSB batteries, all are rechargeable, highly efficient, leak proof and maintenance free.



► Specification

Cells Per Unit	1
Voltage Per Unit	2
Capacity	1000A h @ 10hr-rate to 1.80V per cell @25 °C (77°F)
Weight	Approx. 62.5 kg(137.8 lbs)
Maximum Discharge Current	6000A(5sec)
Internal Resistance	Approx. 0.35 mΩ
Operating Temperature Range	Discharge: -20°C~50°C (-4°F~122°F) Charge: 0°C~40°C (32°F~104°F) Storage: -20°C~40°C (-4°F~104°F)
Nominal Operating Temperature Range	25°C±3°C (77°F±5°F)
Float Charging Voltage	2.23±0.02/Cell at 25 °C (77°F) Temp. Coefficient ±3.3mV/°C (± 1.8mV/°F)
Recommended Maximum Charging Current Limit	300A
Equalization and Cycle Service	2.35V Temps coefficient ±3.3mV/°C (± 1.8mV/°F)
Terminal	Pb-Ca-Sn Alloy(Recessed Terminal)
Container Material	The container and cover are made of flame retardant plastics which meet UL 94-V0 specifications. The oxygen index level is higher than 28.

CSB-manufactured VRLA (Absorbent Glass Mat type) batteries are UL-recognized components under UL1989.

CSB is also certified by ISO 9001 and ISO 14001.

► Dimensions :

Unit: mm (inch)	Overall Height (H)	Container height (h)	Length (L)	Width (W)
	497±3 (19.57±0.12)	463±3 (18.23±0.12)	303±3 (11.93±0.12)	172±3 (6.77±0.12)

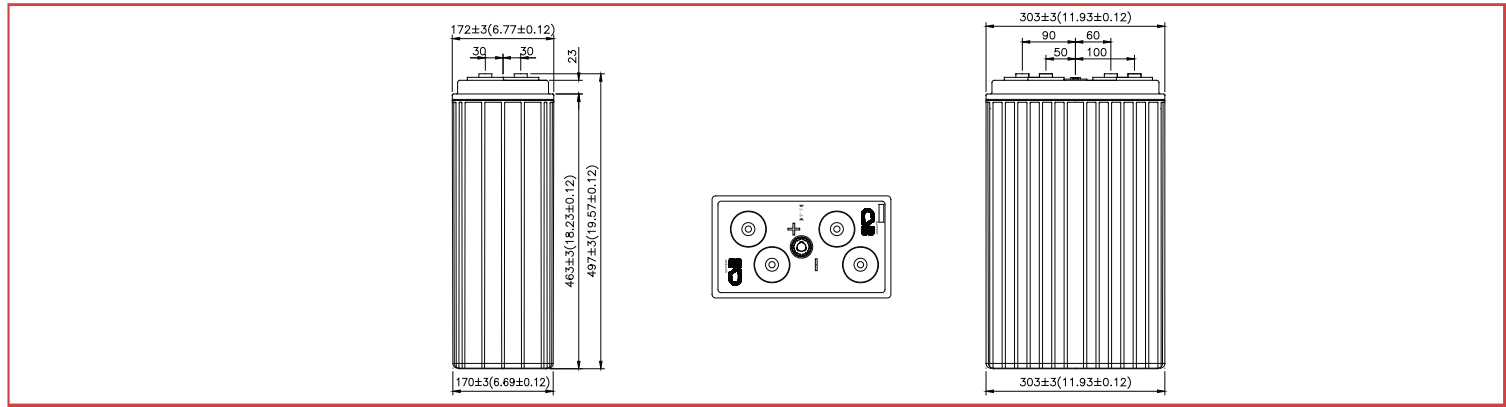

Constant Current Discharge Characteristics Unit:A (25°C, 77°F)

F.V/Time	30MIN	60MIN	90MIN	2HR	3HR	4HR	5HR	6HR	8HR	10HR
1.60V	1087	678	509	417	313	246	205	175	137	112
1.67V	1042	662	498	407	306	242	200	172	134	110
1.70V	983	637	483	394	295	235	194	167	130	106
1.75V	901	602	459	377	283	227	188	162	127	104
1.80V	807	553	427	355	267	216	179	155	122	100
1.83V	714	503	394	331	250	204	169	146	117	95.0

Constant Power Discharge Characteristics Unit:W (25°C, 77°F)

F.V/Time	30MIN	60MIN	90MIN	2HR	3HR	4HR	5HR	6HR	8HR	10HR
1.60V	1707	1173	886	734	554	438	369	317	249	205
1.67V	1678	1152	872	724	548	436	364	315	247	204
1.70V	1642	1121	855	709	534	430	357	311	243	199
1.75V	1541	1066	817	682	515	418	348	303	239	197
1.80V	1420	990	769	650	491	402	335	291	231	190
1.83V	1307	920	725	619	470	388	323	279	225	183

Ratings presented herein are subject to revision without notice. Please refer to www.csb-battery.com to confirm the latest version.

Expected Life V.S Operating Temperature

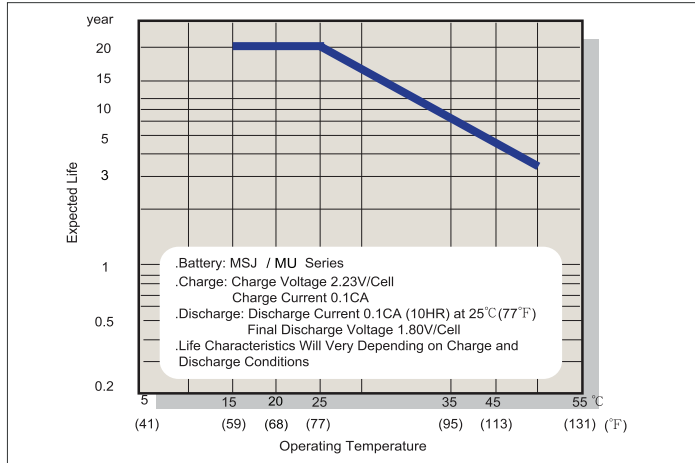

Typical Constant Voltage Charge Characteristics

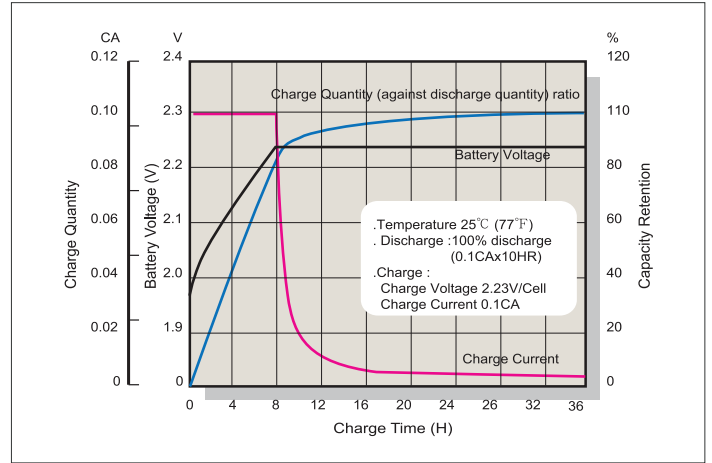

Capacity Retention Characteristics

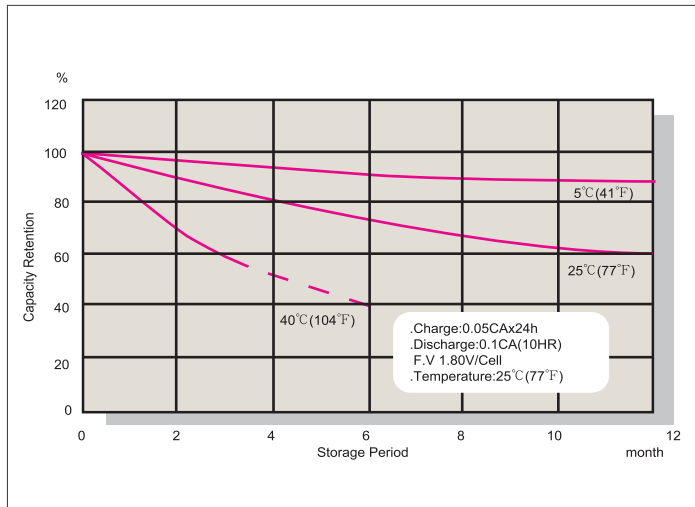

Discharge Characteristics

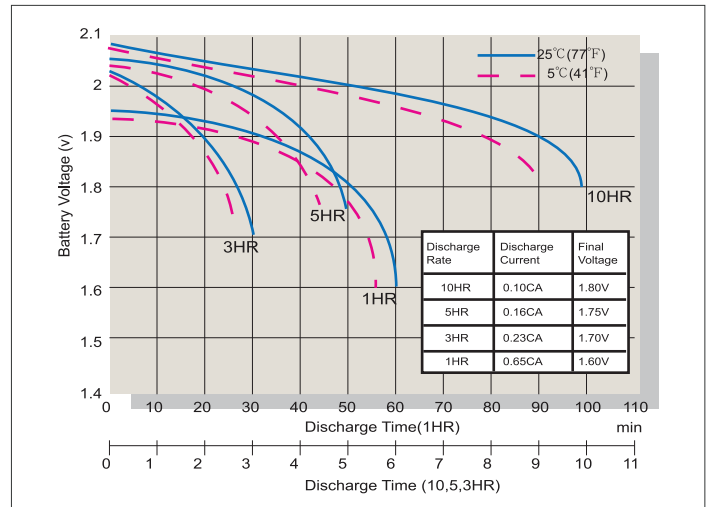

Oxygen Recombination Efficiency Chart

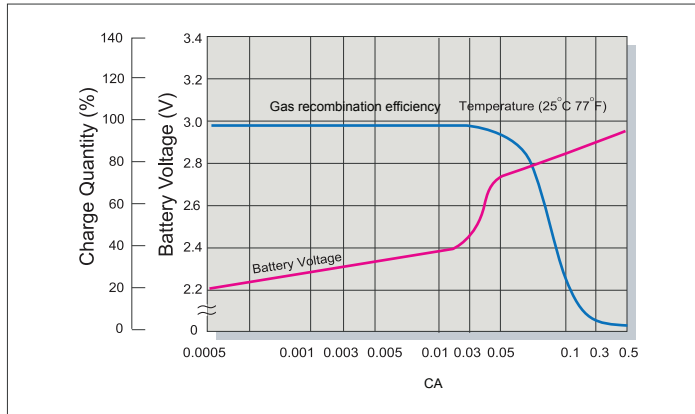

Terminal Voltage (V) and Discharge Time 25°C (77°F)

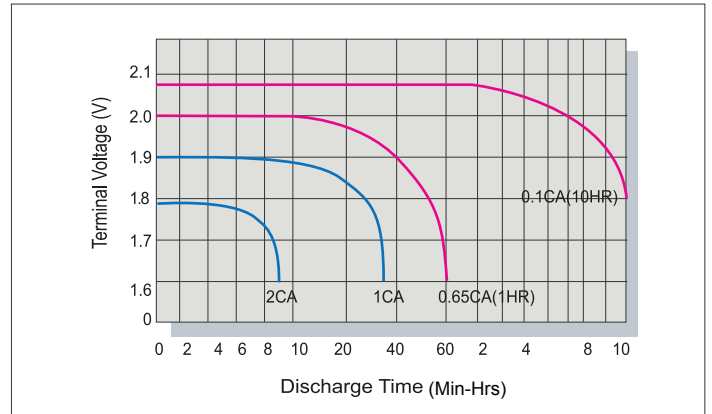

Charging Procedures

Application	Charge Voltage (V/Cell)			Max. Charge Current
	Temperature	Set Point	Allowable Range	
Standby	25°C (77°F)	2.23	2.21~2.25	0.3C

Discharge Current VS. Discharge Voltage

Discharge Current (A)	Final Discharge Voltage (V/Cell)
0.05C > A	1.90
0.15C > A ≥ 0.05C	1.80
0.20C > A ≥ 0.15C	1.75
0.40C > A ≥ 0.20C	1.70
A > 0.40C	1.60

Sales Office URL: WWW.CSB-BATTERY.COM

GLOBAL HQ
CSB BATTERY CO., LTD. (TAIWAN)
 Tel : +886-2-2880-5600
 Fax : +886-2-2888-3300
 mail : service@csb-battery.com.tw

BEIJING OFFICE. (CHINA)
CSB BATTERY TECHNOLOGIES (BEIJING) CO., LTD.
 Tel : +86-10-5820-5336/5338
 Fax : +86-10-58203053
 mail : chinasl@csb-battery.com

AMERICA HQ
CSB BATTERY TECHNOLOGIES INC. (U.S.A)
 Tel : +1-817-244-7777/1-(800)3-CSB-USA(272872)
 Fax : +1-817-244-4445
 mail : csb@csb-battery.com

SHANGHAI OFFICE. (CHINA)
CSB BATTERY LOGISTIC (SHANGHAI) CO., LTD.
 Tel : +86-21-5046-1622/5046-0833
 Fax : +86-21-5064-1046
 mail : chinasl@csb-battery.com

EUROPE HQ
CSB Battery Europe BV.
 Tel : +31(0)-180-418-140
 Fax : +31(0)-180-418-327
 mail : eurosales@csb-battery.eu

SHENZHEN OFFICE. (CHINA)
CSB BATTERY LOGISTIC (SHANGHAI) CO., LTD.
 Tel : +86-755-8831-6488/6396/6356
 Fax : +86-755-8831-6548
 mail : she@csb-battery.com.cn